

Terrace Massive / Terrace Massive Pro Quick Guide P 9360 / P 9369 - P 9552

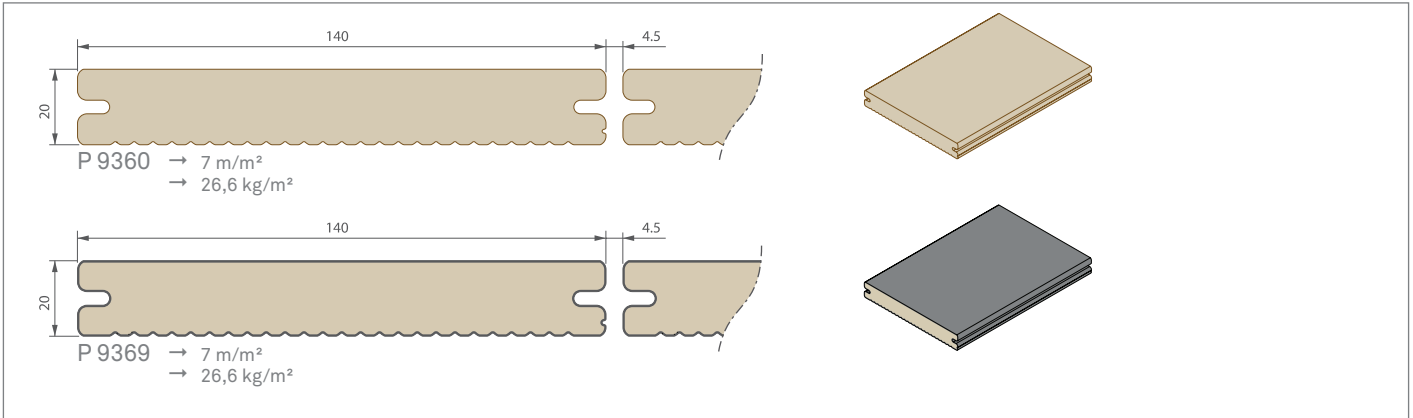

Substructure

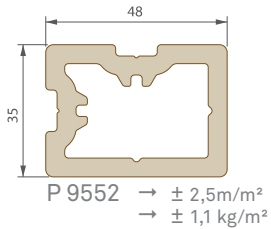

Start/end

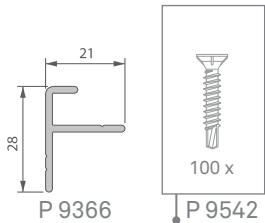

Fixation

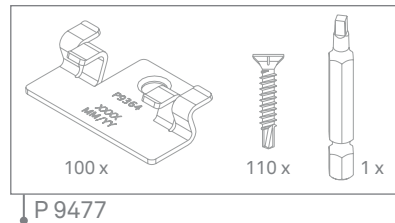

Finishing

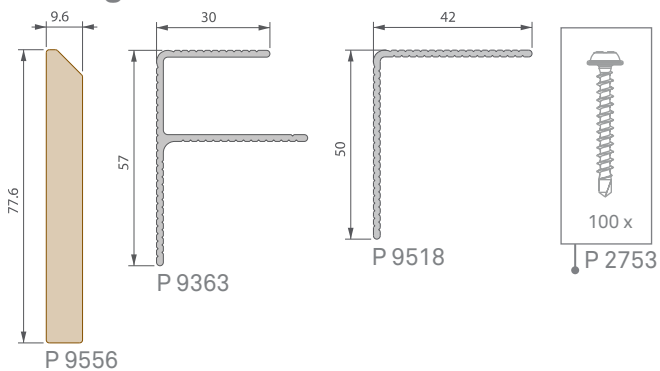

Ventilation

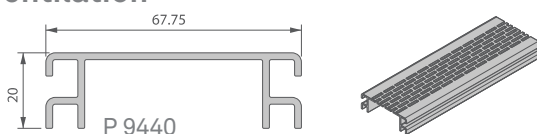

Terrace Massive P 9360 / Terrace Massive Pro P 9369 - P 9552

1 Subfloor | support | ondergrond | Untergrund

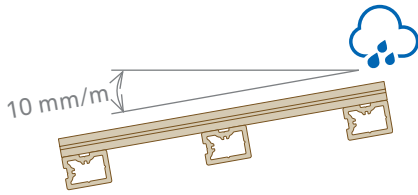

Hinweis: Das Twinson-Material erlaubt auch die Verlegung der Terrassendeckprofile ohne eine Entwässerungsschräge / mit 0°-Gefälle. Es kann dadurch aber verstärkt zur Bildung von Wasserpfützen und Flecken kommen.

Note: The Twinson material allows installation of terrace planks without bevel drainage / with 0° incline. However this may lead to an increasing development of water puddles or stains.

2 Substructure | soubassement | onderstructuur | Unterkonstruktion

Fixed

• Concrete

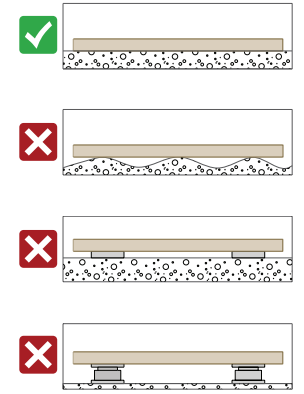
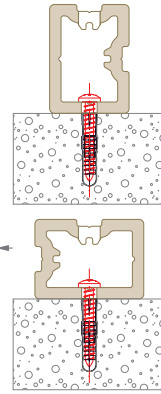
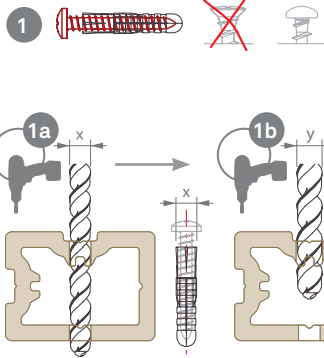
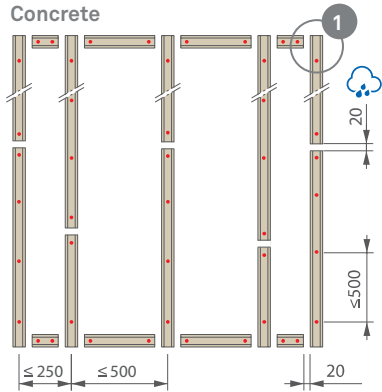

3 General rules | règles générales | algemene richtlijnen | Allgemeine Vorschriften

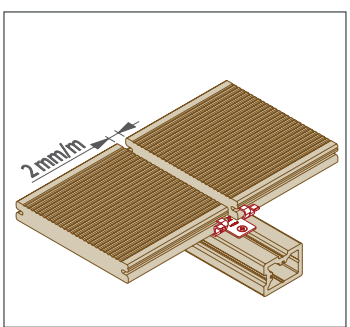
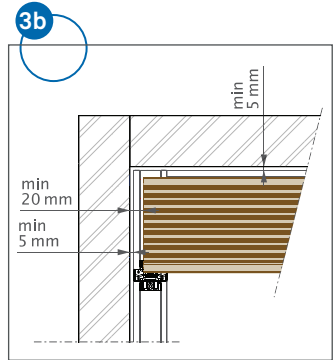
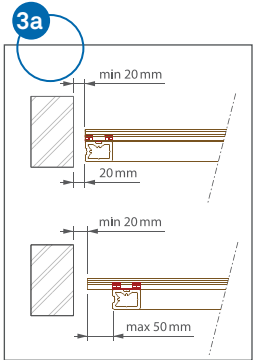
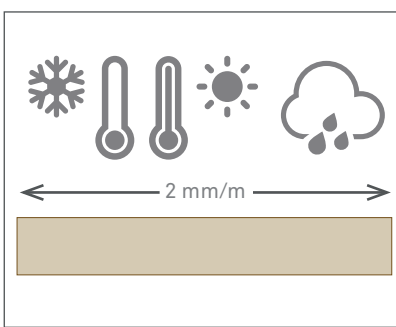
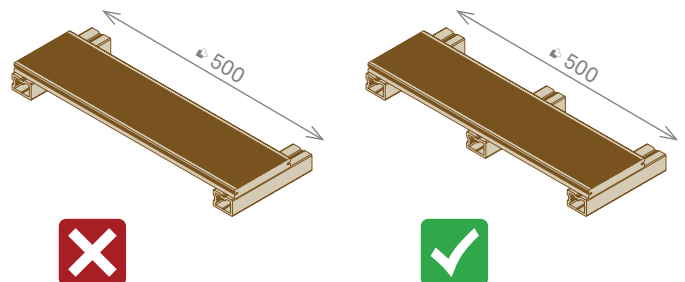
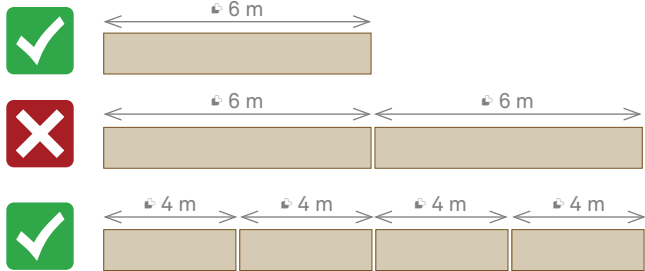

4 Visual aspect | aspect visuel | visueel aspect | visueller Aspekt

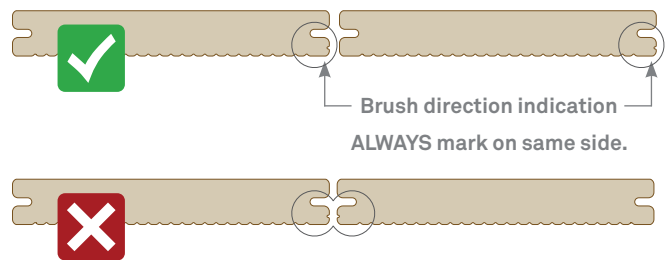
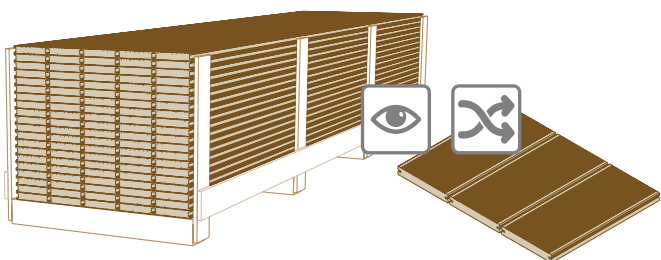

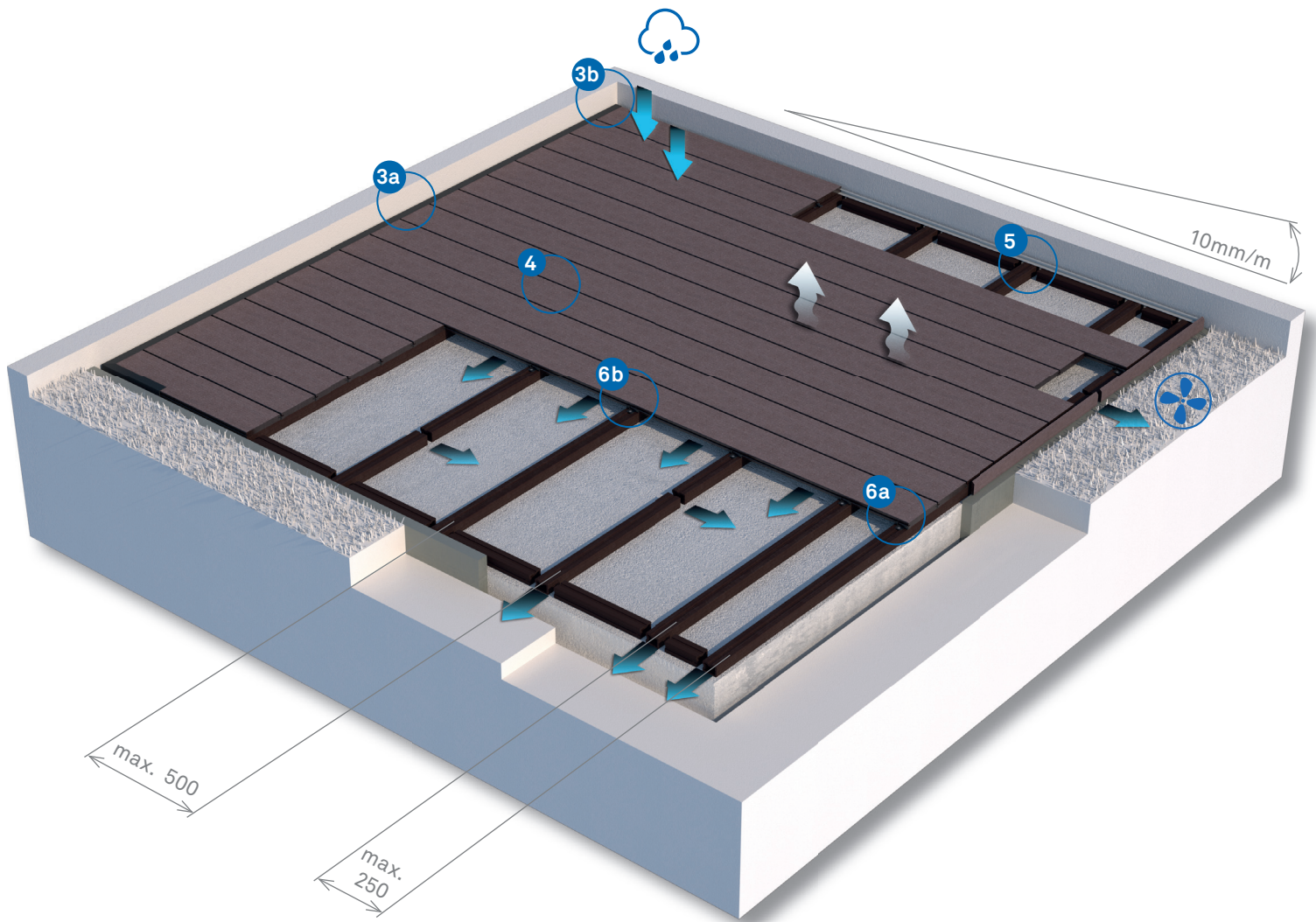

5 Start / end | démarrage / fin | start / einde | Start / Ende

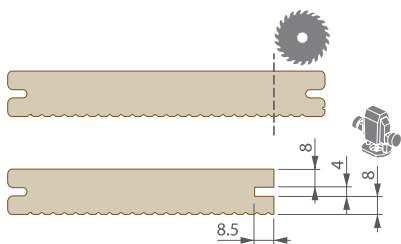
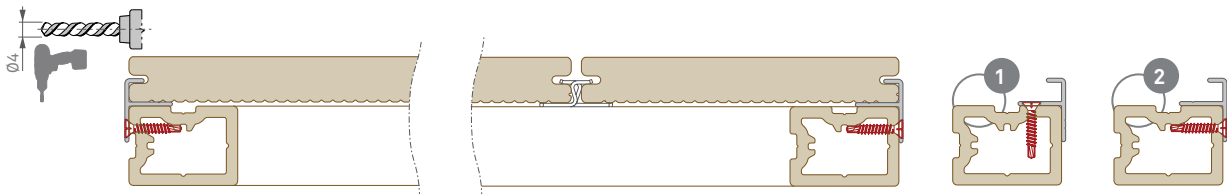

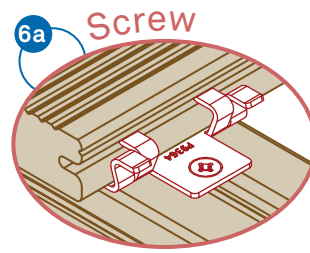
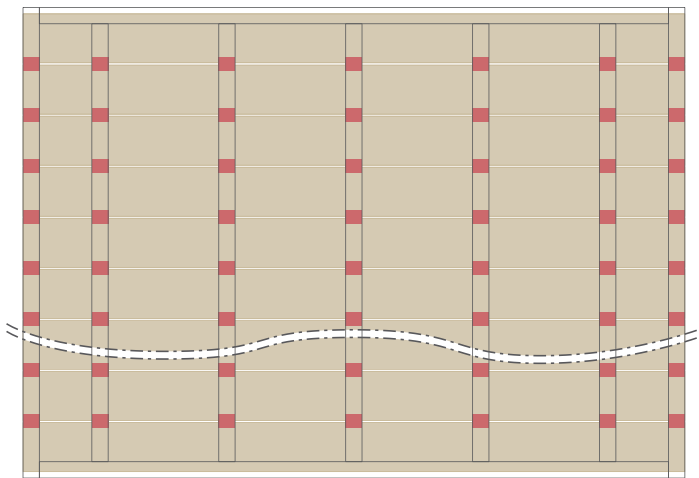

6 Fixation / blocking | fixation / blocage | vastmaken / blokkeren | Fixierung / Blockierung

Step 1: fixation



Step 2: blocking

 direction of expansion  screw
 block

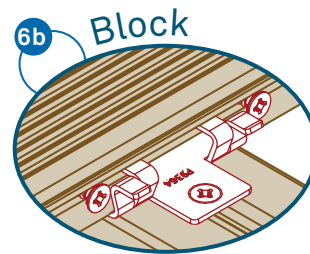

 • Schraube
 Start/Endprofil
 • P 9542

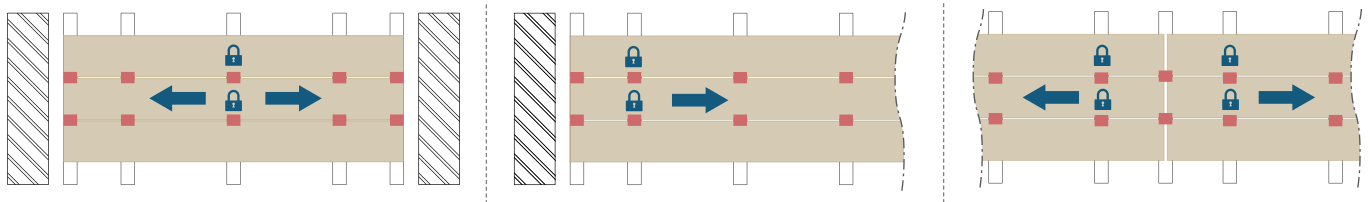

7 Ventilation | ventilation | ventilatie | Belüftung

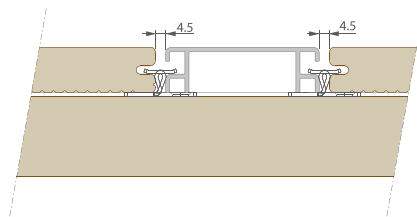
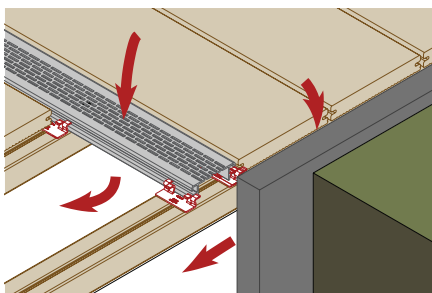

8 Finishing | finition | afwerking | Randabschluss

• Option 1 : P 9363

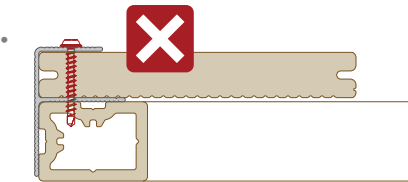
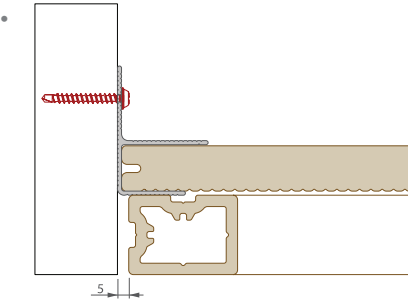
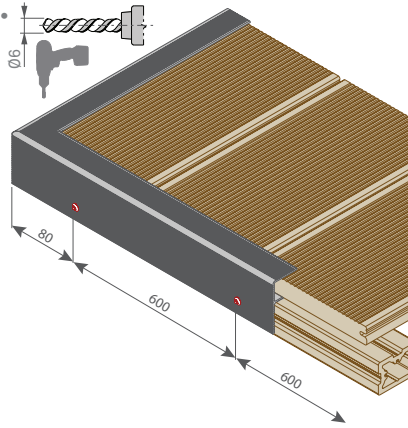
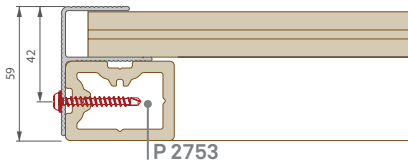

• Option 2 : P 9518

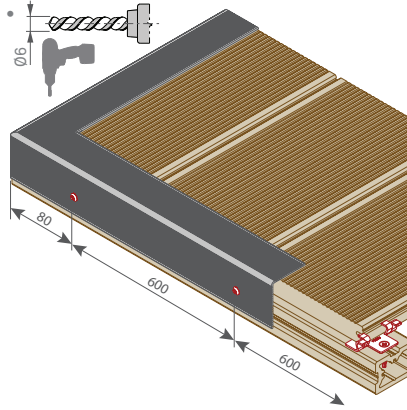
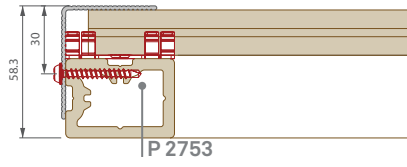

• Option 3 : P 9556

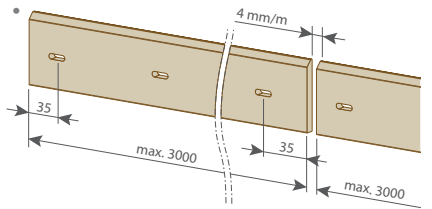
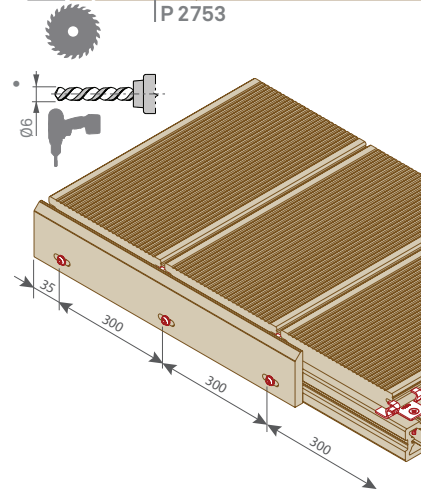
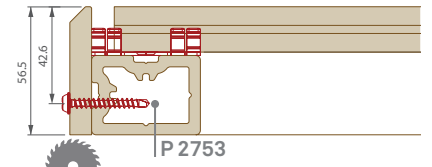

9 Initial cleaning | premier nettoyage | eerste reiniging | Erstreinigung

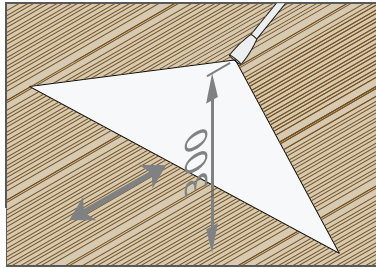

10 Warranty | garantie | garantie | Gewährleistung



The warranty conditions are available on the website or at a local dealer.

Les conditions de garantie sont disponibles sur le site internet ou à un distributeur local.

De garantievoorwaarden zijn beschikbaar op de website of bij de lokale verdeler

Die Garantiebestimmungen finden Sie auf unserer Homepage oder bei Ihrem Fachhändler vor Ort.

Tools

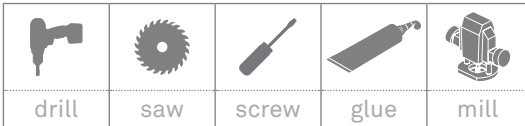

Recommended safety equipment



EN | Inoutic composed this brochure with the utmost care. Nevertheless, data contained in this brochure might be outdated, incomplete, and/or inaccurate. No rights, claims, commitments or guarantees can be derived from the presented information. The texts, photographs, logos, pictures and brands (among which Inoutic, Linktrusion and Twinson included) are covered by intellectual property rights. They are exclusive property of Inoutic. Nothing included in this publication can, fully or partially, in any way be reproduced without prior permission.

The available profiles and accessories may vary depending on your location. To find out which profiles and accessories are available in your area, see www.inoutic.com or contact a local dealer.

Please consult the up to date installation manual on our website www.inoutic.com | All dimensions in mm unless otherwise specified.

FR | Inoutic a composé cette brochure avec le plus grand soin. Cependant, il est possible que les données qui y sont mentionnées ne soient plus actuelles ou se révèlent incomplètes et/ou incorrectes. Les informations communiquées ne sont assorties d'aucun droit, convention, promesse ou garantie. Les textes, photos, logos, illustrations et marques cités (notamment Inoutic, Linktrusion et Twinson) sont protégés par des droits de propriété intellectuelle et sont la propriété exclusive de Inoutic. Aucune partie de cette édition ne peut être reproduite en tout ou en partie, de quelque manière que ce soit, sans l'autorisation préalable de l'ayant droit. Nos conditions de vente, disponibles sur demande, sont d'application.

Les profils et les accessoires disponibles peuvent varier en fonction de votre région. Pour connaître les profils et les accessoires disponibles en charge dans votre région, consultez www.inoutic.com ou un distributeur local.

Consultez les instructions d'installation les plus récentes sur le site www.inoutic.com | Toutes les dimensions sont en mm, sauf indication contraire.

NL | Inoutic stelt dit document met de grootst mogelijke zorgvuldigheid samen. Desondanks is het mogelijk dat de in deze brochure opgenomen gegevens niet actueel, onvolledig en/of onjuist zijn. Aan de weergegeven informatie kunnen geen rechten, aanspraken, toezeggingen of garanties worden ontleend. Op de opgenomen tekst, foto's, logo's, afbeeldingen en merken (waaronder Inoutic, Linktrusion en Twinson) rusten intellectuele eigendomsrechten. Ze zijn exclusief eigendom van Inoutic. Niets uit deze uitgave mag zonder voorafgaande toestemming geheel of gedeeltelijk en op enigerlei wijze worden gereproduceerd.

De beschikbare profielen en accessoires kunnen verschillen per regio. Om na te gaan welke profielen en accessoires beschikbaar zijn in uw regio, raadpleeg www.inoutic.com of een lokale verdeler.

Raadpleeg de meest recente installatierichtlijnen op onze website www.inoutic.com | Alle afmetingen staan in mm, tenzij anders vermeld.

DE | Inoutic hat diese Broschüre mit äußerster Sorgfalt angefertigt. Trotzdem könnten die Daten in dieser Broschüre möglicherweise inaktuell, unvollständig und/oder unrichtig sein. Aus den Informationen können keine Rechte, Ansprüche, Zusagen oder Garantien abgeleitet werden. Die veröffentlichten Texte, Fotos, Logos, Abbildungen und Marken (u.a. Inoutic, Linktrusion und Twinson) sind geistiges Eigentum von Inoutic. Sie sind ausschließliches Eigentum von Inoutic. Es ist nicht erlaubt, Inhalte dieser Dokumentation ohne vorherige Zustimmung, völlig oder teilweise, zu reproduzieren.

Die Verfügbarkeit der Profile und Zubehörteile ist vom jeweiligen Inoutic-Standort abhängig. Um herauszufinden, welche Profile und Zubehörteile in Ihrer Region verfügbar sind, besuchen Sie unsere Homepage www.inoutic.com oder kontaktieren Sie Ihren Fachhändler vor Ort.

Bitte beachten Sie die aktuelle Montageanleitung auf unserer Homepage www.inoutic.com | Wenn nicht anders gekennzeichnet, sind alle angegebenen Maße in Millimeter.